

JING JIN EUROPE

Filtration Equipment

Official dealer of JING JIN EQUIPMENT since 2014





JING JIN EUROPE

FILTRATION EQUIPMENT



COMPANY

In 2014, JING JIN EUROPE was established as the first official dealer of Jinjing Equipment Inc. based in Italy. With decades of experience in the sector, JING JIN EUROPE is well-positioned to meet the ever-growing demand for reliable and efficient solutions.

Jinjing Equipment Inc. was established in 1988 and has since become a leading provider of environmental protection services. We specialize in the production of filter equipment, the development of comprehensive filter technology solutions, and the contracting and operation of environmental protection projects. We are proud to be the Vice-President Unit of the China Environmental Protection Industry Association and the primary drafter of national standards for filter presses. Jingjin trademark has been honored as a 'Famous Chinese Trademark' and is protected by Madrid International Trademark Registration. For seventeen consecutive years, Jingjin filter press has been the largest producer and seller in the world, and for four consecutive years, Jingjin filter cloth has held the same title. Our products have been exported to 123 countries and regions, and we are proud to have earned the respect and admiration of our customers. We strive to be the best craftsmen in the nation.

Jingjin is dedicated to staying ahead of the curve, innovating rapidly, and providing maximum value to our customers! We strive to develop cutting-edge technologies and products, driving the industry forward. Our ultimate goal is to become the most influential and comprehensive environmental service provider in the world.

The purpose of JING JIN EUROPE is to provide European customers with a reliable logistics base located in Italy and a small production unit, allowing for a zero-time material supply. Our experienced and professional team is dedicated to ensuring that all requests for materials and spare parts are responded to within 48 hours.

JING JIN EUROPE combined with more than 57 exclusive agents in extra CEE countries, forming a perfect distribution network and a professional support team giving the customer the right solution for every filtration problem.





JING JIN EUROPE

FILTRATION EQUIPMENT



APPLICATIONS

At **Jing Jin Europe**, we are proud to offer a wide range of products and services to meet the needs of many different sectors and industries. Our products are suitable for use in chemical plants, food and beverage production, waste water treatment plants, metallurgy plants, and mineral and mining operations. We understand the unique needs of each sector and strive to provide the best possible solutions for our customers. Our team of experts is always available to answer any questions you may have and to provide the best possible advice. Our products are designed to be versatile and suitable for a variety of applications. We have products that are suitable for use in industrial, commercial, and residential settings. No matter what your application is, we are confident that we have the right product for you. We are able to provide custom products to meet your specific needs. Our team of experts can work with you to develop a product that meets your exact requirements. We are committed to providing the best possible solutions for our customers.

We are confident that you will be satisfied with the quality and performance of our products. We will work with you to find a solution that meets your needs.



CHEMICALS



FOOD



MINING



WASTE WATER



CERAMICS



METALLURGY



JING JIN EUROPE
FILTRATION EQUIPMENT



CONTENTS

RECESSED FILTER ELEMENT

MEMBRANE & COMPANION
FILTER ELEMENTS

GASKETED FILTER ELEMENT

FILTER CLOTH

ACCESSORIES

STOCKED PRODUCTS

CONTACTS

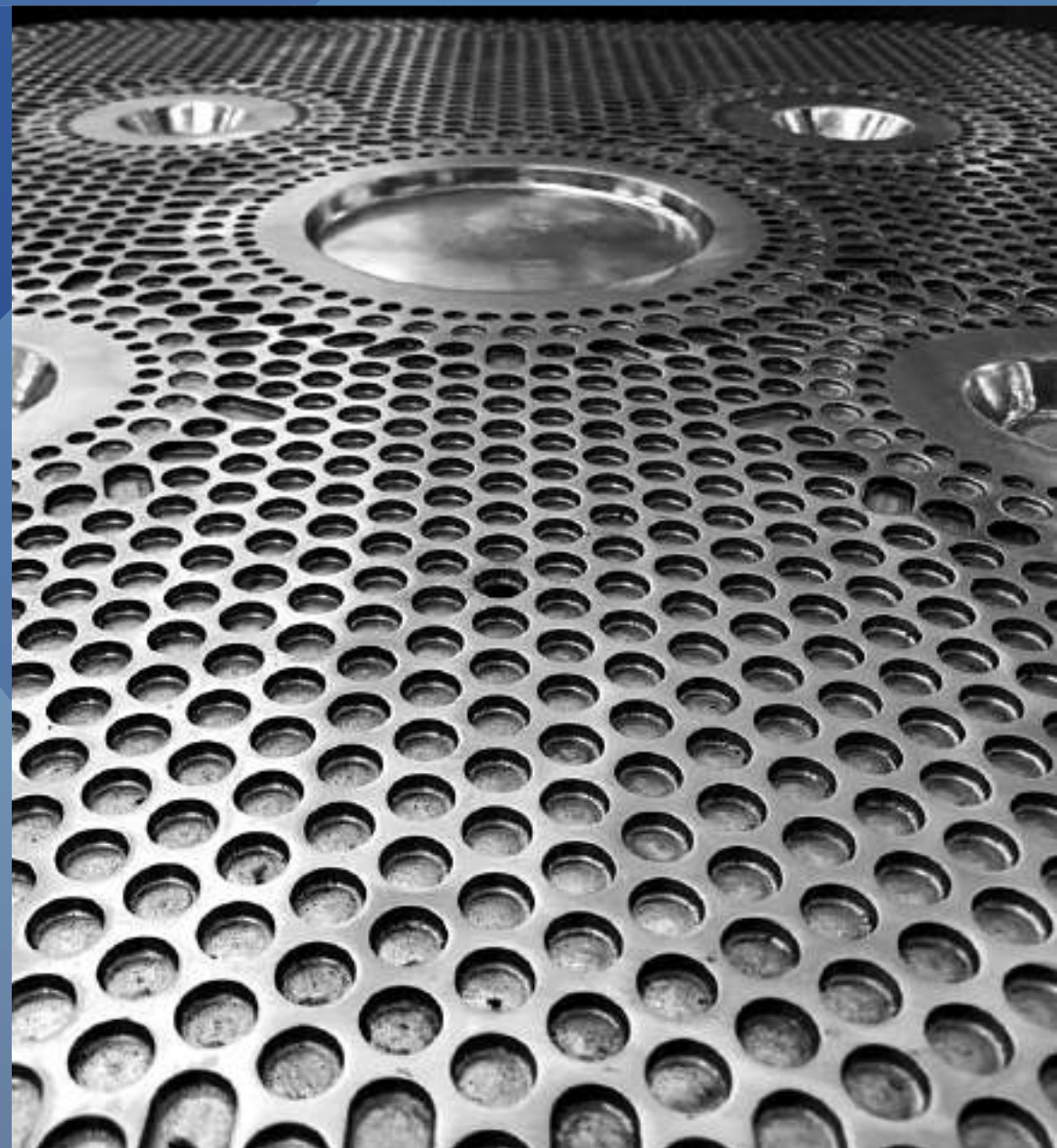

JING JIN EUROPE

FILTRATION EQUIPMENT







CHAMBER FILTER PLATE

A **recessed chamber** plate is a type of filter element that is designed to fit into a filter press. It is made of a durable material such as polypropylene and is designed to hold a filter cloth or other filter media.

The **recessed chamber** plate is designed to create a chamber that can be filled with a slurry or other liquid, which is then filtered through the filter media. Recessed filter plate is widely used for filtration processes with normal dry solid filtration demands. JJ recessed plates are available in PPH or PPC, with four types of feeding position: top, center, corner and outside.

We are able to supply recessed plates from 250x250 to 2500x2600, Our **recessed plates** are suitable to be used from 16 to 21 bar at 40° C. Different chamber thickness are available in our mold range.

Furthermore, the advantages of **recessed plates** can be summarized as low moisture content of the materials by high pressure filtration, high recovery of solid matter with clear filtrate and easy maintenance. Our filter plates are designed to work on high temperature and pressure process.

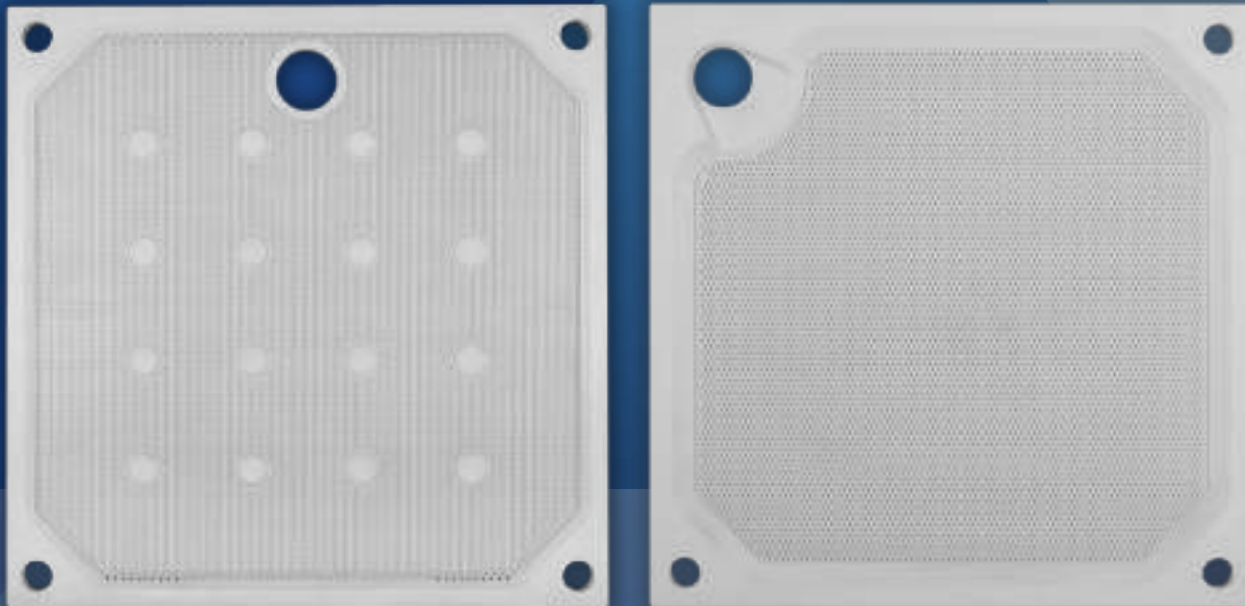



JING JIN EUROPE

FILTRATION EQUIPMENT



MEMBRANE & COMPANION FILTER PLATES

Our **Membrane block filter plate** is designed to reduce filter cake moisture content and shorten filtration cycle time. It is constructed by heat welding a face membrane to a core plate, creating a homogeneous plate with a chamber below the drainage surface.

This chamber can be inflated using either water or air pressure, which is generated by pumping into the squeeze cavity to press the face of the filter plate against the filter cake.

To further reduce costs, we offer Mixed Pack Membranes in combination with **companion chamber plate**, which are the most common configuration for our customers. With this product, you can save on operating costs and enjoy a more efficient filtration process.

Our **Membrane filter plate** is designed to work in a variety of fields, pressures, and temperatures. It is constructed to be durable and reliable, so you can trust that it will perform well in any environment.

Our lead time for mixed pack is typically 3-4 weeks, depending on the size and complexity of the order.

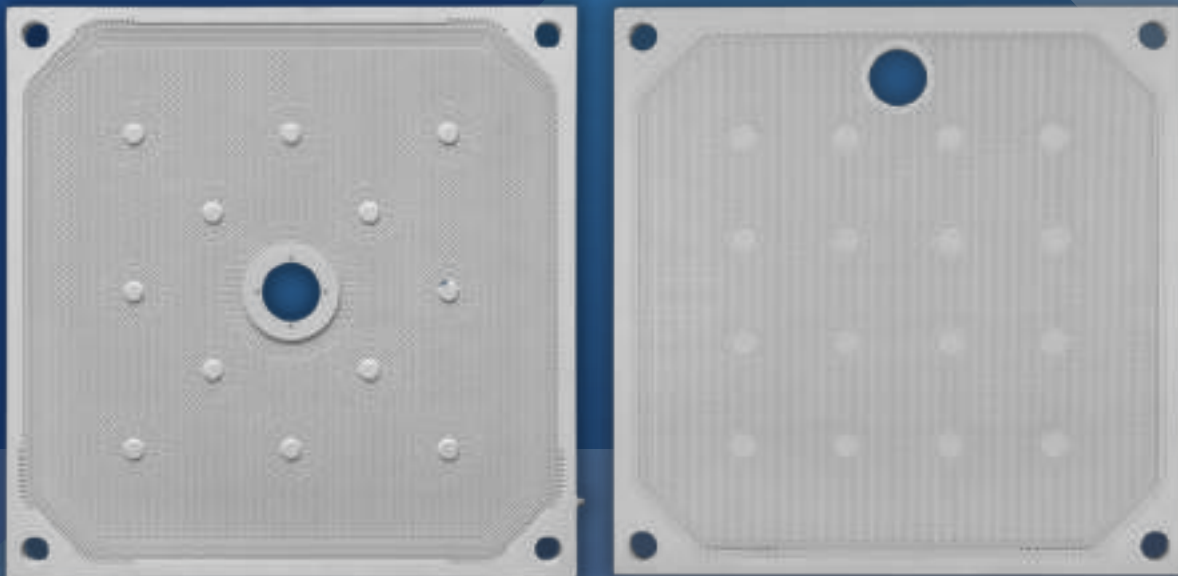





GASKET FILTER PLATE

Gasketed Filter Plates are the latest in Recessed Chamber plate technology. Featuring a filter cloth that is fitted into the groove inside the slit of the plate, these plates are designed with an O-ring that is fitted into the sealing edge when the plate is closed, ensuring a secure seal with no leakage.

The O-rings are manufactured with different elastomers such as EPDM, Viton or natural rubber depending on the application. Installation and dismantling of the cloth is easy and requires minimal maintenance.

Gasketed Filter Plates are available with corner, top, centre or bottom feeding, and can be used for 8 to 16 bar pressures at 40°C with adjustable chamber thickness. Gasketed Filter Plates can be produced in Polypropylene (PPH or PPC) which offers excellent chemical/corrosion resistance, resistance to high temperatures, and the ability to handle high pressure and flow. They can also be produced in Polypropylene for food applications like winery and beer production.

To help customers save time, JJEU are able to supply **Gasketed Filter Plates** with the filter cloth already installed.

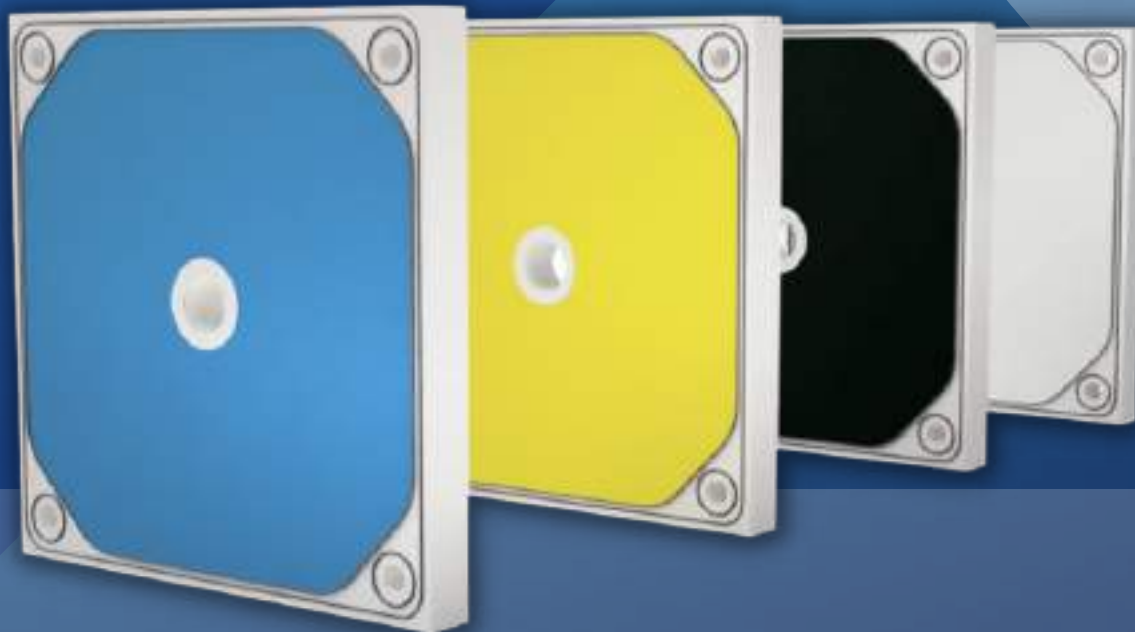
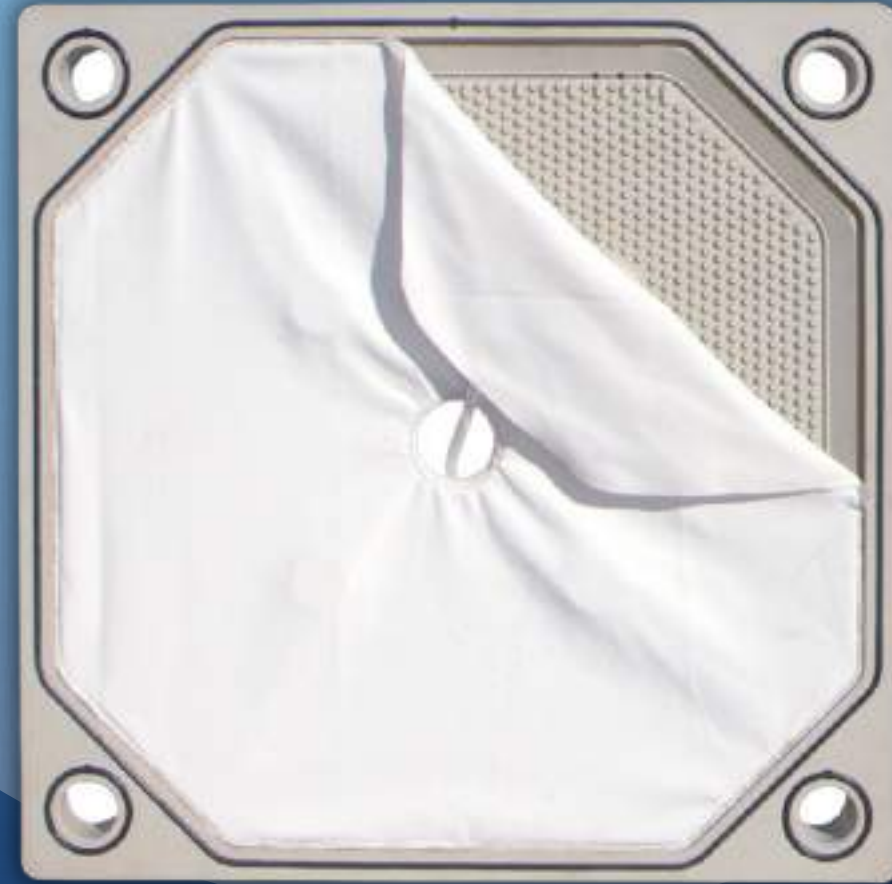





ACCESSORIES

Jing Jin Europe offer a complete set of filter plates **accessories** as support handles, distribution rings, nozzle for open discharge execution with or without ball valve. Our products come with a range of accessories to make your experience even better.

Our **accessories** are made from high-quality PPH and designed to provide maximum support and durability. Our support handles, pivot, and distribution rings are all designed to ensure a secure and reliable connection between components.

Our **accessories** are designed to provide a long-lasting and reliable connection, ensuring your products are safe and secure.

With these **accessories**, you can customize your product to fit your needs and make sure you get the most out of it.

Our products are designed to be highly flexible and adaptable. With our range of accessories, you can tailor your product to fit your needs.

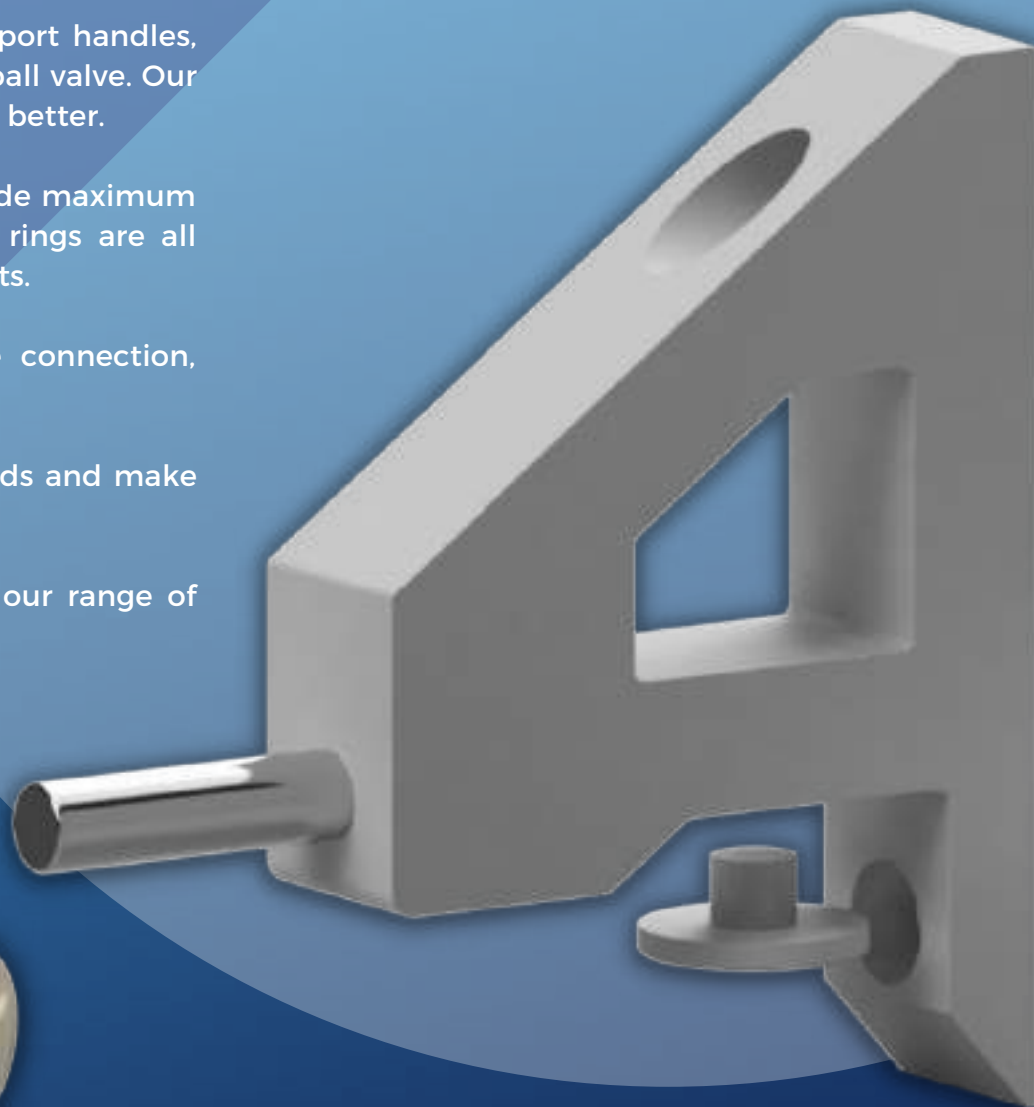



JING JIN EUROPE

FILTRATION EQUIPMENT

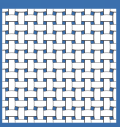

FILTER FABRICS & FILTER CLOTH

JingJin Europe is a leading provider of filter fabrics, offering a wide range of products with superior filtration capabilities. With over 30 years of experience in the filtration industry, JingJin introduce a complete set of German filter cloth production line and technology. By virtue of JingJin's 30 years of filtering experience, the heavy German rapier looms weave the thinnest silk threads into filter cloth of high density and different hole patterns by using 0.3-0.5 tons beating-up force after each weft across warp.

Under same area the filtration holes of JingJin filter cloth are 50% more than other filter cloth, which improve the filtration speed greatly. What's the most important is that monofilament filter cloth can make the filter cakes fall off automatically, which has conquered the unsolved problem ever since.

Jing Jin can easily produce filter fabrics rolls and delivery it in every part of the world.

Furthermore, JingJin has also introduced a high-end production line of polypropylene yarn drawing. The raw material used is of high quality fiber-grade polypropylene, allowing for the production of polypropylene yarn of high tenacity with different norms from 100D to 5000D, and a strength of 7-8.5g/D. With their advanced production line and technology, JingJin is able to provide filter fabrics of the highest quality and ship them to any part of the world.





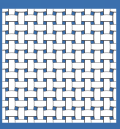

FILTER FABRICS & FILTER CLOTH

The uniformity, tensile strength and surface smoothness of yarn, etc. index have exceeded national standard; the yarn twisting equipment adopts advanced single-spindle and single-control two-for-one twisters, which guarantees uniformity and accuracy of degree of yarn twist; after thermoforming, the stability of cohesive force, degree of twist, and drying shrinkage rate is high, and the divation of yarn size is controlled within $\pm 1\%$ and the deviation of drying shrinkage within $\pm 0.5\%$.

Jingjin has introduce high-end production line of polypropylene yarn drawing, and the raw material adopts high quality fiber-grade polypropylene, which can produce polypropylene yarn of high tenacity with different norms from 100D to 5000D, and the strength can reach 7-8.5g/D.

The uniformity, tensile strength and surface smoothness of yarn, etc. index have exceeded national standard; the yarn twisting equipment adopts advanced single-spindle and single-control two-for-one twisters, which guarantees uniformity and accuracy of degree of yarn twist; after thermoforming, the stability of cohesive force, degree of twist, and drying shrinkage rate is high, and the divation of yarn size is controlled within $\pm 1\%$ and the deviation of drying shrinkage within $\pm 0.5\%$.

JingJin Europe is a reliable source for filter fabrics, offering a wide selection of products with superior filtration capabilities. With their advanced production line and technology, JingJin is able to provide filter fabrics of the highest quality and ship them to any part of the world.

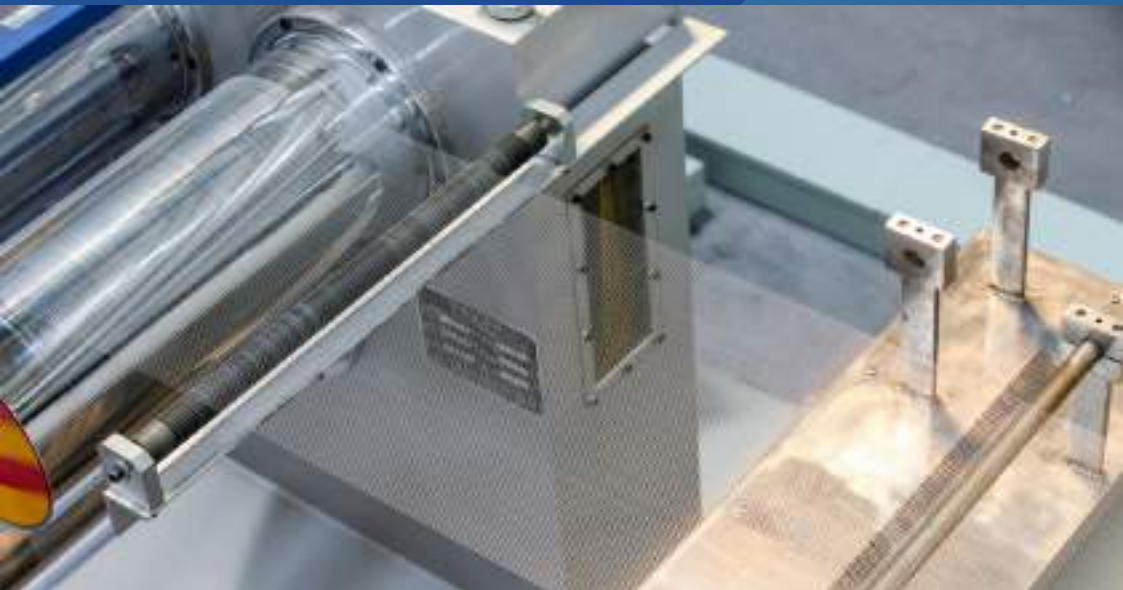



JING JIN EUROPE

FILTRATION EQUIPMENT

STOCKED PRODUCTS



Thanks to our **warehouse** located in Bergamo in the north of **Italy**, **JJEU** are able to provide our products **within 48 hours**, all around the European country using express courier service.

NOT ONLY filter plates, in our warehouse we stock all components necessary, from **filter fabrics** to pivot, from **support handles** to threaded inserts.

Our customer are able to check the availability quantities just taking a look to our website, where there's a dedicate page to our stocked plates. Our **warehouse** in Italy provides **fast and reliable delivery** of our products to customers across Europe.

With a team of experienced professionals, we are able to deliver our products to any **European country** within **48 hours**. We ensuring that our **products are always in stock** and ready to be shipped. We are committed to providing our customers with the highest quality products and the **fastest delivery** times.

Our team of experts is here to **help** you choose the **right products** for your needs.





JING JIN EUROPE

FILTRATION EQUIPMENT



CONTACT

www.jj-europe.com

Eng. Alessandro
Limonta
GENERAL MANAGER
info@jj-europe.com
+39 344 19 43 007

Paola Villa
ACCOUNTING DEPART.
amministrazione@jj-europe.com
+39 035 03 31 125

Alessandro Lipari
SALES MANAGER
sales@jj-europe.com
+39 377 18 50 690



FOLLOW OUR SOCIAL MEDIA



JING JIN EUROPE

FILTRATION EQUIPMENT



www.jj-europe.com



JING JIN EUROPE

FILTRATION EQUIPMENT

